

MINI-CIRCUITS  
NEW  
**MMIC**  
PRODUCTS

**Excellence in  
Performance**

**Peace of Mind**

Lifetime Product Supply  
Commitment to Excellence in Quality  
Easy to Do Business with

 **Mini-Circuits®**  
ISO 9001 ISO 14001 AS 9100 CERTIFIED

[www.minicircuits.com](http://www.minicircuits.com)



<b>CONTENTS</b>	<b>PAGES</b>
<b>INTRODUCTION</b>	<b>3</b>
<b>APPLICATION</b>	<b>4</b>
<b>MINI-CIRCUITS MMIC TECHNOLOGIES</b>	<b>5 - 9</b>
State of The Art MMIC Design	
Semiconductor Materials & Processes	
Circuit Architectures	
Design-in-chip Quality & Reliability	
Evaluation Board Design	
<b>NEW MMIC PRODUCTS</b>	<b>10 - 19</b>
Low Noise Amplifiers	
Wideband Microwave Amplifiers	
High Dynamic Range Amplifiers	
Digital Variable Gain Amplifiers	
Wideband Power Splitters / Combiners	
Wideband Frequency Mixers	
Frequency Multipliers	
<b>QUALITY MANUFACTURING PROCESS &amp; CONTROL</b>	<b>20 - 22</b>
Advanced Packaging Technology	
Comprehensive Test & Characterization	
Dynamic Test Specification	
Stringent Qualification	
<b>COMPANION PRODUCTS &amp; OTHER RESOURCES</b>	<b>23</b>
<b>MODEL SEARCH &amp; WORLD WIDE TECH SUPPORT</b>	<b>24</b>

X-Parameters is a registered trademark of Agilent Technologies. All other trademarks cited in this publication are the property of their respective owners. Neither Mini-Circuits nor Mini-Circuits MMIC amplifiers are affiliated with or endorsed or sponsored by the owners of the above referenced trademarks. Mini-Circuits and the Mini-Circuits logo are registered trademarks of Scientific Components Corporation.

© Mini-Circuits 2016. All rights reserved.

# INTRODUCTION

Mini-Circuits offers one of the industry's broadest selections of MMIC products up to 40.0 GHz.

Mini-Circuits MMIC in-house design center utilize GaAs semiconductor materials and PHEMT, HBT, IPD process technologies, our designs offer a very wide variety of performance characteristics to meet your needs including low noise, flat gain, ultra wideband, digital variable gain and more.

This MMIC new product lines overview guide provides you with a complete overview of our MMIC design capabilities and also a highlight of Mini-Circuits excellent MMIC products. As one of the few suppliers in the industry who own and manage their own packaging facilities, Mini-Circuits is able to provide the highest quality, most consistent, and most reliable products to our customers.

From here, we invite you to visit [minicircuits.com](http://minicircuits.com) and use **Yoni2**<sup>®</sup>, our patented search engine that lets you search our entire engineering database by performance criteria to find the models that meet your requirements. You'll also find complete specs for individual models, free samples of selected products, high accuracy simulation models, and everything you need to make an informed decision about the right MMIC products for your needs. We're always here to support you. Get in touch with our applications team to discuss any questions or special requirements you might have. We thank you for your interest in Mini-Circuits MMIC products.



# APPLICATION

- ▶ Point to Point Radio
  - ▶ SATCOM
  - ▶ Cellular
  - ▶ Portable Wireless
  - ▶ PCS
  - ▶ LTE
  - ▶ WiMAX
  - ▶ GPS
  - ▶ Wireless Base Station Systems
  - ▶ UHF / VHF
  - ▶ CATV
  - ▶ Multi-Band Receivers
  - ▶ Test & Measurement
  - ▶ Instrumentation
  - ▶ Military EW
  - ▶ Avionics Systems
  - ▶ Radar
  - ▶ Isolation Amplifiers
  - ▶ Balanced Amplifier
  - ▶ Optical Networks
- and More!



# MINI-CIRCUITS MMIC TECHNOLOGIES

As a global leader of RF, IF and microwave components, Mini-Circuits offers MMIC products to satisfy today's and future high performance demands.

Mini-Circuits always expands boundaries of our design capabilities and continuously develop advanced MMIC technologies. We also invest heavily in advanced design tools and state of the art RF test and measurement systems.

## State of The Art MMIC Design

To achieve high success rate at the first design cycle, Mini-Circuits MMIC design center utilizes advanced design tools in circuit simulation, harmonic balance simulation, full wave 3D EM simulation, thermal simulation and layout design.

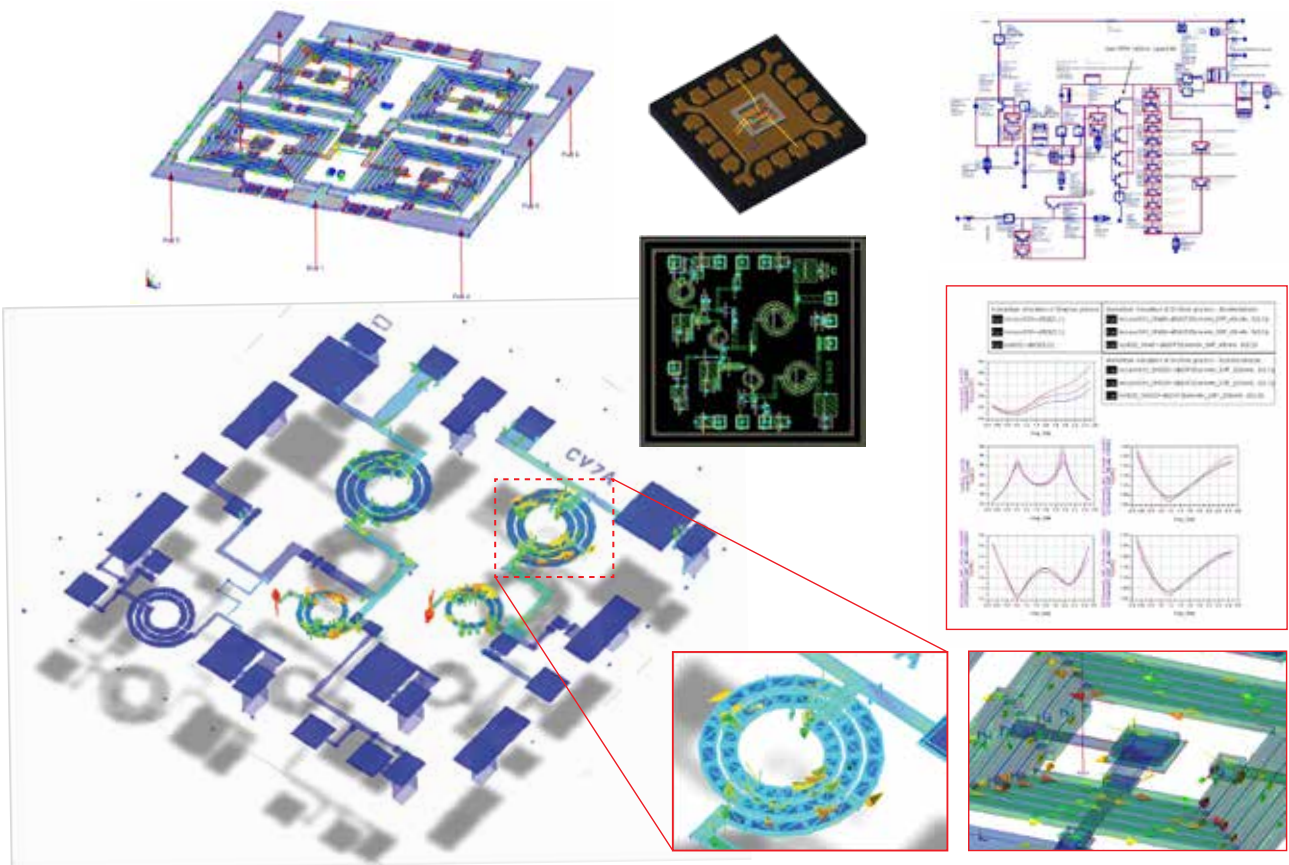

# Semiconductor Materials and Processes

## Why GaAs?

- ▶ High electron mobility enables high frequencies and fast switching performance
- ▶ Intrinsic GaAs is semi-insulating, making it an ideal substrate for stripline and high Q passives
- ▶ Large Band Gap 1.4eV enables higher power operation
- ▶ Radiation hardness means GaAs is well accepted for both space and military applications
- ▶ Commercially available in 6" wafer, making it suitable for mass production
- ▶ GaAs is widely accepted as the superior technology for the production of high frequency, high power and low noise products

GaAs Material Properties	
Electron Mobility (cm <sup>2</sup> /Vs)	5,500 – 7,000
Peak Drift Velocity (10 <sup>7</sup> cm/s)	1.6 – 2.3
Band Gap (eV)	1.4
Frequency Range (GHz)	> 75
Gain	High
Noise Figure	Good
Production Maturity	6" Wafer

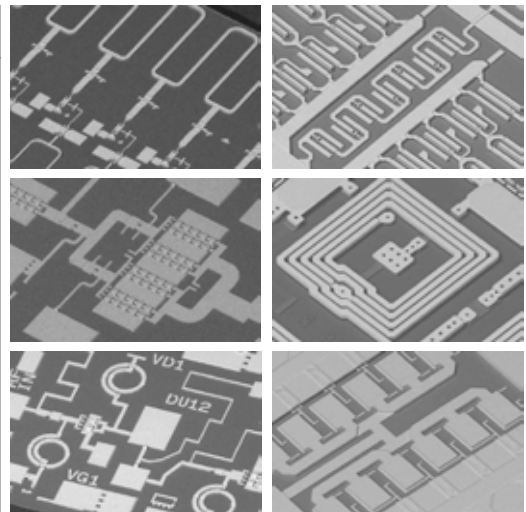

GaAs pHEMT	GaAs InGap HBT	GaAs IPD
0.5/0.25/0.15 μm E-mode and D-mode	2μm / 1μm	2μm
<b>Products:</b> <ul style="list-style-type: none"> <li>• Low Noise Amplifiers</li> <li>• High Linearity Gain Block</li> <li>• Distributed Amplifiers</li> <li>• mmWave Power Amplifiers</li> </ul> <b>Features:</b> <ul style="list-style-type: none"> <li>• High transition frequency (Ft)</li> <li>• Low noise up to mmWave</li> <li>• E-mode (single supply)</li> <li>• High linearity</li> <li>• High power density</li> <li>• Great power and efficiency</li> <li>• Low standby current</li> <li>• May operate as low as 1.2V</li> </ul>	<b>Products:</b> <ul style="list-style-type: none"> <li>• High Linearity Gain Block</li> <li>• Power Amplifiers &lt;6GHz</li> </ul> <b>Features:</b> <ul style="list-style-type: none"> <li>• High current gain</li> <li>• High power density</li> <li>• High linearity and efficiency (PAE)</li> <li>• Single supply</li> <li>• Consistent product performance</li> <li>• Proven technology for gain block and medium power amplifiers</li> </ul>	<b>Products:</b> <ul style="list-style-type: none"> <li>• Filters</li> <li>• Diplexers</li> <li>• Baluns</li> <li>• Power splitters</li> <li>• Combiners</li> <li>• Couplers</li> <li>• Transformers</li> </ul> <b>Features:</b> <ul style="list-style-type: none"> <li>• Eliminate microphonics phenomenon</li> <li>• High current handling</li> <li>• High power dissipation</li> <li>• Excellent thermal dissipation</li> <li>• High reliability and repeatability</li> </ul>

# Circuit Architectures

Mini-Circuits MMIC designs employ a range of different circuit topologies to give our customers a wide variety of choice to meet their system requirements.

Whether the goal is to achieve wideband performance, high dynamic range, ultra low noise or other critical performance characteristics, the right circuit architecture allows our design engineers to strike the ideal balance of parameters for your needs.

## Darlington

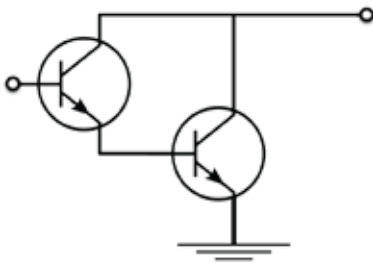

### Features:

- High current gain ( $\beta$ )
- Superior IP3 bandwidth
- Flat gain
- Great impedance match

### Applications:

- IF gain block
- Multi purpose driver amplifiers

## Cascode

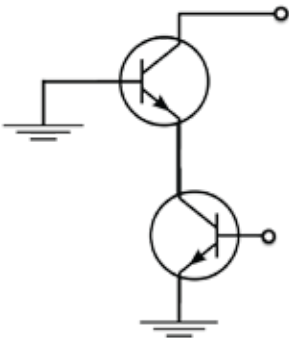

### Features:

- Improves input-output isolation
- Reduces the Miller effect
- Wide bandwidth
- High gain
- High output impedance
- High supply voltage
- High IP3

### Applications:

- Low noise amplifier

## Distributed

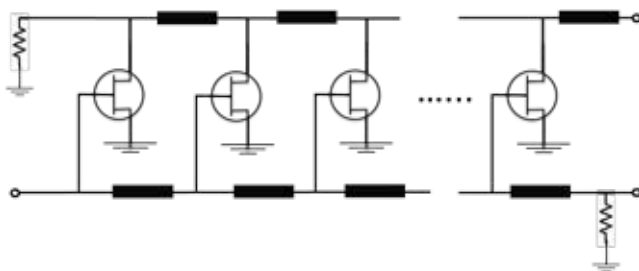

### Features:

- Broadband performance
- Good impedance match
- Flat gain
- Excellent isolation

### Applications:

- Radars
- Point to point radio
- Test instruments

# Design-in-chip Quality & Reliability

## Active Biasing

As changes in temperature can cause changes in amplifier characteristics, temperature stability is mandatory to maintain the performance of the amplifier.

Mini-Circuits MMIC amplifier designs utilize an active biasing circuit consisting of components that have the same temperature characteristics as the amplifier to improve temperature stability.

RF signals are isolated from the active biasing circuit, preventing degradation in RF performance.

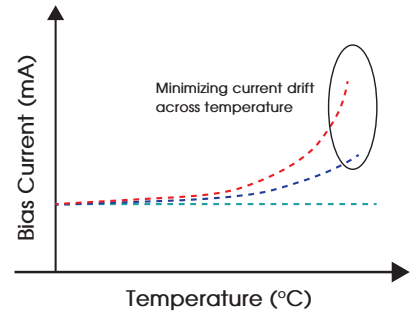

- ..... Ideal Case (Fix biasing across temperature)
- ..... Passive Biasing
- ..... Active Biasing

## Protection Circuitry

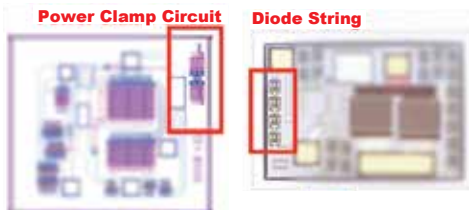

### ESD Protection Circuit

Designed-in ESD protection circuitry provides an alternate low resistance path for ESD, reducing current flow to critical circuits, and improving ESD survivability and product reliability.

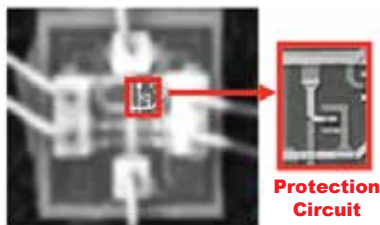

### Transient Current Protection Circuit

Voltage spikes may cause permanent damage to MMIC amplifiers. Built-in transient current protection circuitry prevents damage caused by voltage spikes without degrading the amplifier's RF performance.

## Junction Temperature Monitoring

We also measure and monitor MMIC amplifier junction temperature using embedded temperature sensing diodes near the transistor junction on every design and every production wafer to ensure we provide the highest quality and reliability in our amplifiers.

**Temperature Sensing Diode near Transistor Junction**

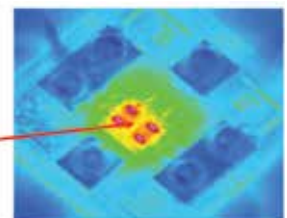



# Evaluation Board Design

Mini-Circuits designs and manufactures evaluation board for all MMIC products.

These evaluation boards are able to help customers to reduce their design effort. All required components such as bypass capacitors, DC blocks, biasing resistors and RF chokes are assembled on board.

Heat dissipation issues are taken care of by proper heat sinking with a brass case. Mini-Circuits also include Voltage Control Module (VCM) on the evaluation boards for products that require voltage sequencing and DC control.

This module enables plug-and-play operation without the need for external voltage sequencing circuits.



# NEW MMIC PRODUCTS



Low Noise Amplifiers

Wideband Microwave Amplifiers

High Dynamic Range Amplifiers

Digital Variable Gain Amplifiers

Wideband Power Splitters / Combiners

Wideband Frequency Mixers

Frequency Multipliers

# Low Noise Amplifiers

Ranging from 40 to 8000 MHz, Mini-Circuits low noise MMIC amplifier model families provide noise figures as low as 0.38dB, making them ideal for sensitive receiver applications.

Our selection provides various combinations of gain, P1dB, IP3, power consumption and size to meet a wide range of system requirements.

For wideband operation 500 to 8000MHz, Mini-Circuits' new model **PMA3-83LN+** has the unique combination of low noise, high IP3, and flat gain over a wideband making it ideal for sensitive, high-dynamic-range receiver applications. This design operates on a single 5V or 6V supply, is well matched for 50Ω and comes in a tiny, low profile package (3 x 3 x 0.89mm), accommodating dense circuit board layouts.

Mini-Circuits low noise amplifiers are also available with bypass features, such as **TSS-53LNB+**, TSS-53LNB+ features an internal switchable bypass circuit to protect the LNA in the presence of high power signals, minimize noise distortion and extend the usable dynamic range to up +48dBm in bypass mode.

Model Number	Frequency Range (MHz)	Gain (dB)	P1dB (dBm)	Noise Figure (dB)	IP3 (dBm)	DC Bias
<b>PMA3-83LN+</b>	500 to 8000	22.1	20.7	1.3	35.2	5V, 60mA/6V, 77mA
<b>TSS-53LNB+</b>	500 to 5000	21.7	20.6	1.4	33.9	5V, 82mA
<b>PMA-545+</b>	50 to 6000	14.2	20.3	0.8	36.4	3V, 80mA
<b>PMA-545G1+</b>	400 to 2200	31.3	22.2	1.0	33.6	5V, 158mA
<b>PMA2-33LN+</b>	400 to 3000	19.1	17.2	0.4	34.5	3V, 56mA
<b>PMA2-43LN+</b>	1100 to 4000	19.9	19.9	0.5	32.9	5V, 51mA
<b>PMA2-162LN+</b>	700 to 1600	22.7	20.0	0.5	30.0	4V, 55mA
<b>PMA2-252LN+</b>	1500 to 2500	17.6	17.8	0.8	30.0	4V, 57mA
<b>PMA4-33GLN+</b>	700 to 3000	38.9	22.6	0.5	40.4	5V, 152mA
<b>PGA-103+</b>	50 to 4000	11.0	22.5	0.9	44.6	3V, 60mA/5V, 97mA
<b>PGA-105+</b>	40 to 2600	15.1	20.5	1.9	39.3	5V, 63mA
<b>PSA-545+</b>	50 to 4000	14.9	20.2	1.0	36.2	3V, 80mA
<b>PSA-5451+</b>	50 to 4000	14.0	16.2	1.0	30.2	3V, 30mA
<b>PSA-5453+</b>	50 to 4000	14.7	19.4	1.0	36.8	3V, 60mA
<b>PSA-5454+</b>	50 to 4000	13.6	14.0	1.1	26.3	5V, 20mA
<b>PSA-5455+</b>	50 to 4000	14.4	18.5	1.0	32.2	5V, 40mA
<b>PSA4-5043+</b>	50 to 4000	18.4	18.8	0.8	33.5	3V, 33mA/5V, 58mA
<b>SAV-541+</b>	45 to 6000	17.6	19.2	0.5	33.1	3V, 60mA
<b>SAV-551+</b>	45 to 6000	15.9	17.5	0.5	24.3	3V, 15mA
<b>SAV-581+</b>	45 to 6000	17.0	19.0	0.5	30.6	3V, 30mA
<b>TAV-541+</b>	45 to 6000	17.9	19.1	0.5	33.6	3V, 60mA
<b>TAV-551+</b>	45 to 6000	16.3	17.5	0.5	23.5	3V, 15mA
<b>TAV-581+</b>	45 to 6000	17.3	18.3	0.5	30.3	3V, 30mA



**PMA3-83LN+**  
(0.5-8GHz)

- Low Noise figure, 1.3 dB at 2 GHz
- High IP3, + 35 dBm typ. at 2 GHz
- High Pout, P1dB + 20.7 dBm typ. at 2 GHz
- Excellent Gain flatness, ±0.9 dB over 0.5 to 7 GHz

NOISE FIGURE vs. FREQUENCY & DEVICE VOLTAGE  
Temperature = +25°C

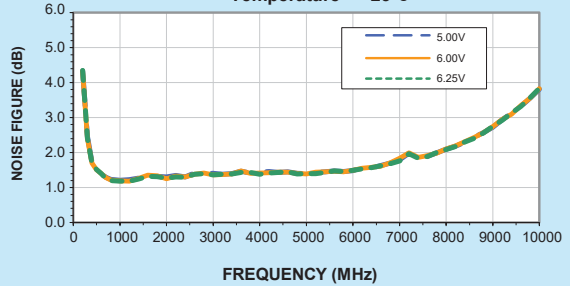

**TSS-53LNB+**  
(0.5-5GHz)

- Integrated Bypass Switch
- Noise Figure: as low as 1.2 dB
- ± 0.7 dB flatness over 700 to 2100 MHz
- P1dB + 21 dBm typ.
- IP3, + 34 dBm in thru mode
- IP3, + 48 dBm in bypass mode
- Gain 21.7 dB typ. at 2 GHz

NOISE FIGURE vs. FREQUENCY & DEVICE VOLTAGE  
Ve=5.0V, Temperature = +25°C

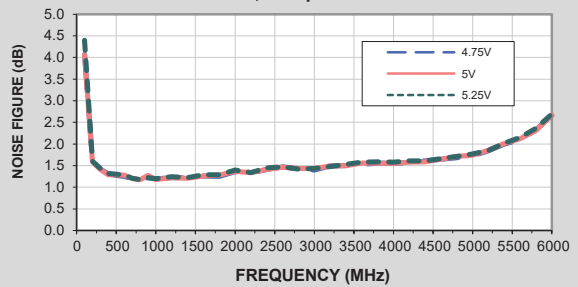

**PMA4-33GLN+**  
(0.7-3GHz)

- Low Noise Figure, 0.54 dB at 900 MHz
- High IP3, + 40 dBm typ. at 900 MHz
- High Pout, P1dB + 22.6 dBm typ. at 900 MHz
- High Gain, 39 dB at 900 MHz

NOISE FIGURE vs. FREQUENCY & DEVICE VOLTAGE  
Temperature = +25°C

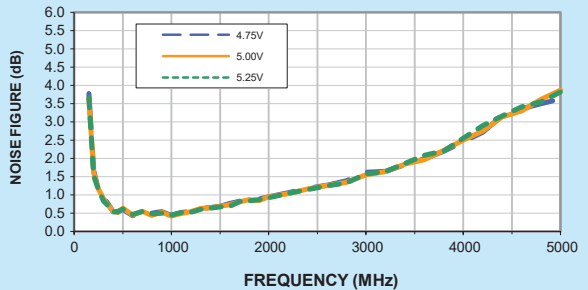

**PGA-103+**  
(0.05-4GHz)

- 5V/3V operation
- High IP3, + 45 dBm typ. at 2 GHz, Vd=5V
- Low Noise Figure, 0.6 at 1 GHz; 0.9 dB at 2 GHz
- Gain, 11.0 dB typ. at 2 GHz
- P1dB + 22.5 dBm typ. at 2 GHz at Vd=5V

NOISE FIGURE vs. FREQUENCY & DEVICE VOLTAGE  
Temperature = +25°C

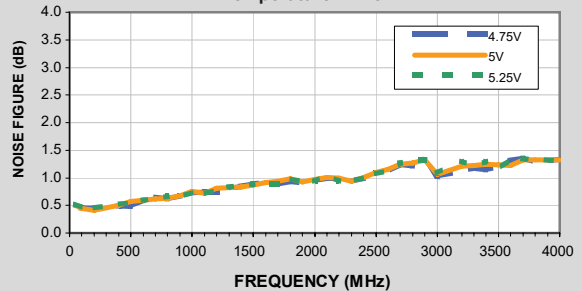

# Wideband Microwave Amplifiers

Covering applications from DC to 26.5GHz, our selection of wideband fixed voltage MMIC amplifiers cover an extremely wide range of applications. With a variety of models offering different performance features including flat gain, high linearity, and output power up to 1/2watt, chances are, we have a model that meets your requirements.

Model Number	Frequency Range (MHz)	Gain (dB)	P1dB (dBm)	Noise Figure (dB)	IP3 (dBm)	DC Bias
<b>GVA-123+</b>	10 to 12000	16.9	16.2	4.0	30.0	5V, 52mA
<b>AVA-24A+</b>	5000 to 20000	11.8	18.4	5.7	25.0	5V, 120mA
<b>AVA-183A+</b>	5000 to 18000	14.0	19.0	5.0	26.0	5V, 131mA
<b>AVM-273HPK+</b>	13000 to 26500	14.0	26.9	8.4	32.1	6V, 559mA



**GVA-123+**  
(10-12000MHz)

- Broadband without external matching components
- Excellent Gain Flatness,  $\pm 0.7$  dB, 0.05-8 GHz
- Gain, 16.9 dB typ. at 2 GHz
- Excellent return loss, 20 dB typ., 2 GHz

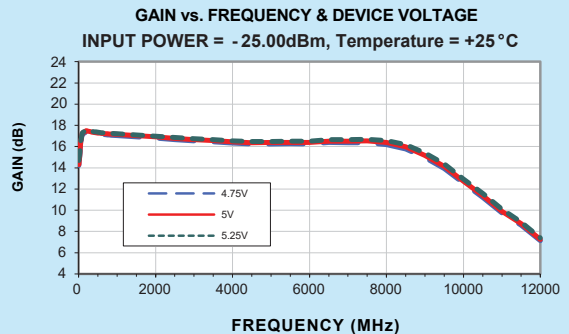

**AVM-273HPK+**  
(13-26.5GHz)

- Wideband 13 to 26.5 GHz
- Output power up to +27 dBm
- Excellent directivity, 43 dB typ. @ 20 GHz
- Unconditionally stable
- Excellent gain flatness,  $\pm 1$  dB
- Sequencing and DC Control module included

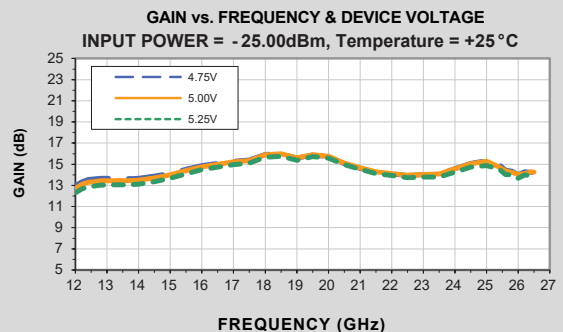

# High Dynamic Range Amplifiers

Mini-Circuits' high dynamic range amplifiers deliver industry-leading dynamic range with OIP3 performance as high as +48dBm. This translates into extremely linear performance in multi-carrier and complex signal environments. Supporting both 50 and 75 ohm systems with a range of supply voltages, these models provide outstanding combinations of intercept point and power consumption for low cost compared to similar products on the market.

HXG-series amplifiers provide the unique combination of very high IP3 and very low noise performance, making them usable as output stage amplifiers and also in receiver front end circuitry. Mini-Circuits System in Packages® (MSiP) technology integrates the matching network with the amplifier in a single, tiny ceramic package, eliminating the need for external matching components.

For specific bandwidth applications, Mini-Circuits offers GVA-91+ and GVA-92+ with high Power Added Efficiency (up to 50%) and deliver high output power (up to +29.5dBm), with low DC power consumption.

Model Number	Frequency Range (MHz)	Gain (dB)	P1dB (dBm)	Noise Figure (dB)	IP3 (dBm)	DC Bias
<b>LHA-1+</b>	50 to 6000	14.1	22.7	2.1	40.0	5V, 146mA
<b>PHA-1+</b>	50 to 6000	13.5	22.4	2.2	42.0	5V, 146mA
<b>PHA-1H+</b>	50 to 6000	13.8	22.6	2.2	41.0	5V, 132mA
<b>PHA-101+</b>	50 to 1500	15.2	26.0	4.0	47.0	9V, 186mA
<b>PGA-122-75+</b>	5 to 1500	15.6	24.3	2.9	43.0	9V, 115mA
<b>HXG-122+</b>	500 to 1200	15.3	23.0	2.2	46.0	5V, 144mA
<b>HXG-242+</b>	700 to 2400	15.0	22.8	2.3	46.5	5V, 144mA
<b>GVA-91+</b>	869 to 2170	20.4	28.8	6.4	40.0	5V, 147mA
<b>GVA-92+</b>	869 to 2170	21.2	24.1	6.0	42.0	5V, 99mA



**PHA-1H+**  
(50-6000MHz)

- High IP3, + 40.4 dBm typ. at 2.4 GHz
- Gain, 13.8 dB typ. at 2 GHz
- High Pout, P1dB + 22 dBm typ. at 2 GHz
- Low noise figure, 2.2 dB @2 GHz
- No external matching components required

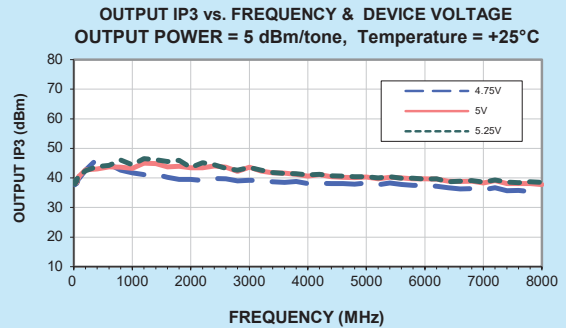

**HXG-242+**  
(700-2400MHz)

- Ultra High IP3, +46 dBm typ. at 1.5 GHz
- Gain, 14.3 dB typ. at 2 GHz
- High Pout, P1dB +23 dBm typ.
- Low noise figure, 2.4 dB
- Internally matched for optimized IP3 performance
- No external matching components required

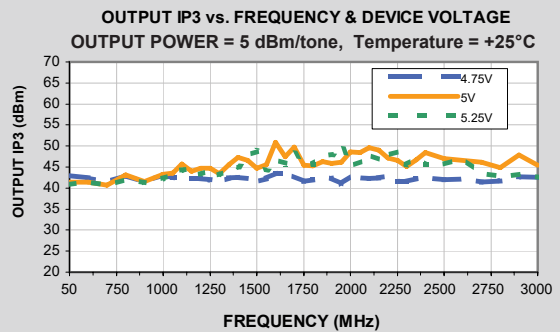

**PHA-101+**  
(50-1500MHz)

- High IP3, + 47dBm typ at 0.9GHz
- Gain, 15.2dB typ at 0.9GHz
- High Pout, P1dB + 26dBm typ at 0.9GHz
- Low Noise figure, 4.0dB at 0.9GHz
- No external matching components required

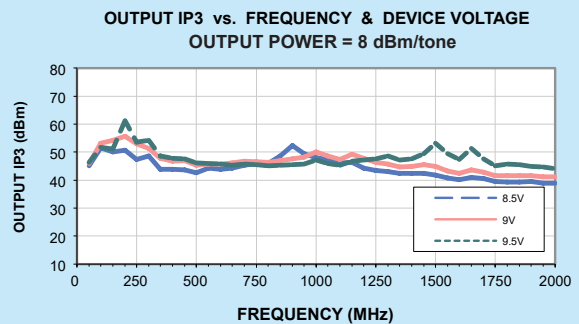

**PGA-122-75+**  
(5 - 1500MHz)

- 75 ohm operation
- High IP3, + 43 dBm typ. at 0.5 GHz
- Gain, 15.6 dB typ. at 0.5 GHz
- High Pout, P1dB +24.3 dBm typ. at 0.5 GHz
- Low Noise Figure, 2.9 dB at 0.5 GHz

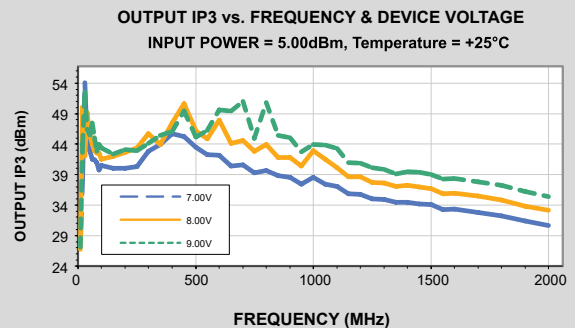

# Digital Variable Gain Amplifiers

Mini-Circuits' DVGA-series of digitally controlled variable gain amplifiers integrate an amplifier with a digital step attenuator in a single, 5 x 5 mm package. They provide gain as high as 30 dB and 31.5 dB gain control in 0.5 dB steps using 6-bit serial or parallel control interfaces. The step attenuators used in DVGA amplifiers are produced using a unique combination CMOS process on silicon, offering the performance of GaAs with the advantages of conventional CMOS devices. They are immune to latch-up and provide  $\pm 0.1$  dB attenuation accuracy enabling very precise gain control.

DVGA-series are packaged in MCLP which has an excellent thermal pad, provides repeatable transitions and low inductance.

Model Number	Frequency Range (MHz)	Gain (dB) 0 dB Step	Attenuation Total (dB)	Attenuation on Step (dB)	Number of Bits	Control Interface	OIP3 (dBm)	P1dB (dBm)	Noise Figure (dB)	DC Bias
DVGA1-242+	450 to 2400	29.5	31.5	0.5	6	Serial	35.7	23.2	3.1	3V/5V, 159mA
DVGA1-242PP+	450 to 2400	29.5	31.5	0.5	6	Parallel	35.7	23.2	3.1	3V/5V, 159mA
DVGA2-33+	50 to 3000	19.2	31.5	0.5	6	Serial	29.6	16.3	5.4	3V/5V, 71mA
DVGA2-33pp+	50 to 3000	19.2	31.5	0.5	6	Parallel	29.6	16.3	5.4	3V/5V, 71mA

## Simplified Schematic for Parallel Control

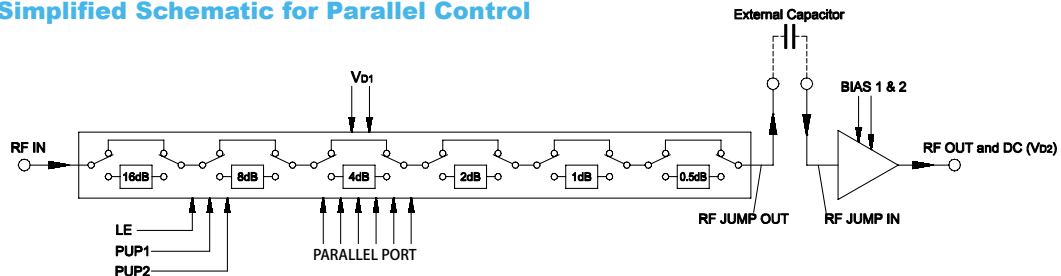

## Simplified Schematic for Serial Control

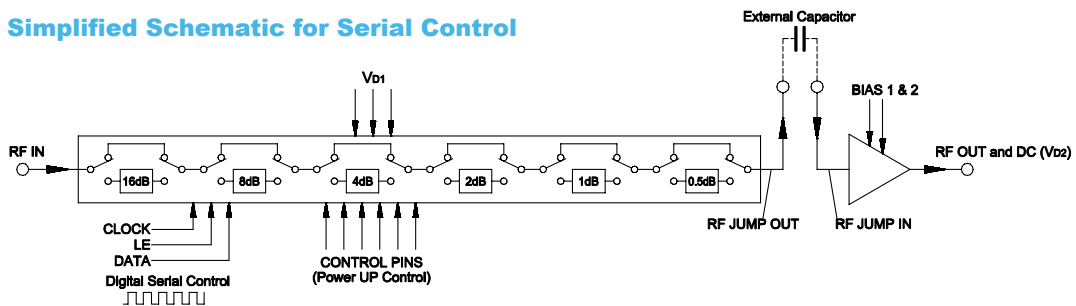

## Multiple Configurations Available

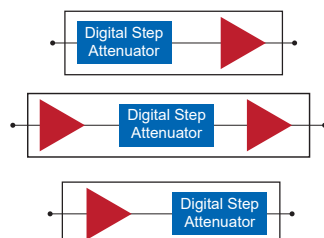



# Wideband Power Splitters / Combiners

Mini-Circuits' new MMIC power splitters/combiners have the widest bandwidth in the industry in a single model. These power splitters/combiners cover the 1.8GHz to 26.5GHz frequency range, provide high performance and high power handling up to 2.5W.

Model Number	Frequency Range (MHz)	Isolation (dB)	Insertion Loss (Above 3dB)	Phase Unbalance (degrees)	Amplitude Unbalance (dB)
<b>EP2C+</b>	1800 to 12500	16	1.1	6.0	0.2
<b>EP2K+</b>	5000 to 20000	20	2.1	4.2	0.1
<b>EP2K1+</b>	2000 to 26500	20	2.4	5.4	0.3
<b>EP2W1+</b>	500 to 9500	20	3.1	3.0	0.6

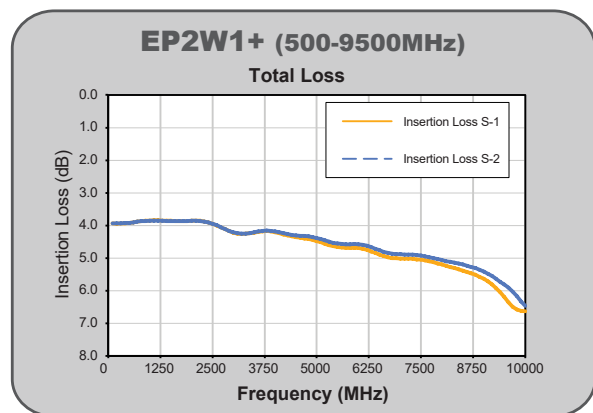
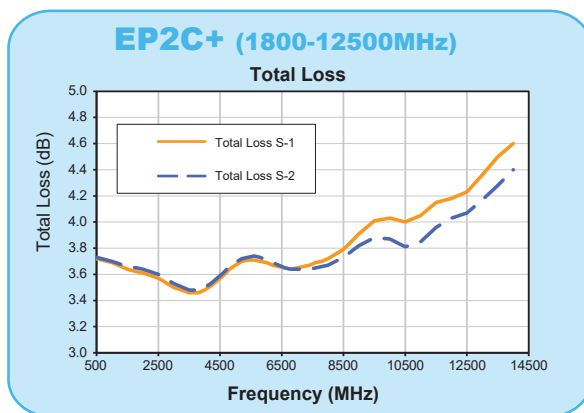
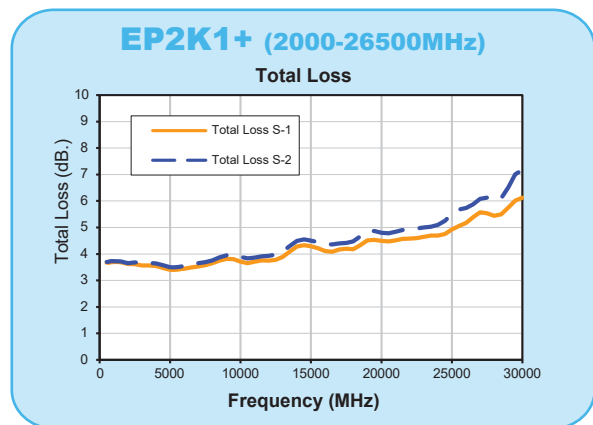
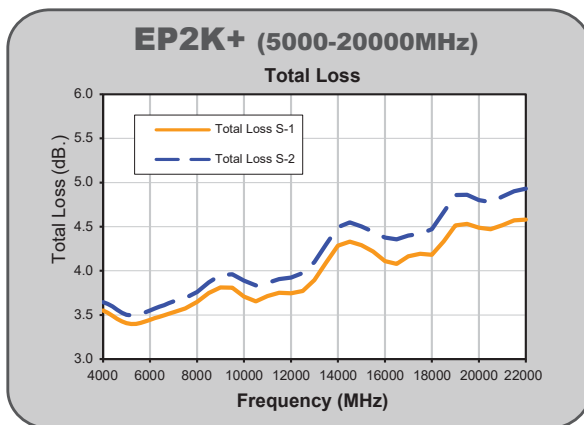
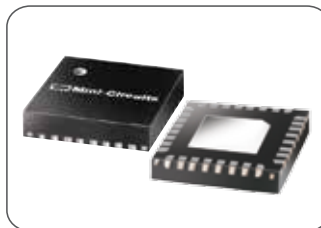

# Wideband Frequency Mixers

Mini-Circuits' new wideband double balanced MMIC frequency mixers provide excellent repeatability and consistent performance over a wide frequency range. Ultra-wideband coverage in a single device make these mixer suitable for wideband systems such as defense communications and radar, as well as a wide variety of narrowband applications from WiFi through Ku band and more. Requiring no DC power, these tiny MMIC mixers measure only 4 x 4 x 1mm, making them especially useful in dense PCB layouts.

Model Number	RF In @ 1dB (dBm)	RF/LO Frequency Range (MHz)	IF Frequency Range (MHz)	Conversion Loss (dB)	LO-RF Isolation (dB)	LO-IF Isolation (dB)	IP3 @ Center Band (dBm)
<b>MDB-24H+</b>	10	5000 to 21500	DC to 5000	7.9	35	44	23
<b>MDB-73H+</b>	10	2200 to 7000	DC to 1600	8.2	39	46	24

Mini-Circuits also offer MDA4-752H+ as a multi-chip device incorporating a wideband mixer, an LO amplifier and an IF amplifier die in a single tiny 4X4mm MCLP package. It has flat conversion gain over a broad frequency range and has high IP3. In addition, the MDA4-752H+ has good input and output return loss over a broad frequency range without the need for external matching components.

Model Number	LO Level (dBm)	RF In @ 1dB Compression (MHz)	RF/LO Frequency Range (MHz)	IF Frequency Range (MHz)	Conversion Gain (dB)	LO-RF Isolation (dB)	LO-IF Isolation (dB)	Output IP3 (dBm)	DC Bias
<b>MDA4-752H+</b>	0	9	2200 to 7000	30 to 1600	9.1	31	61	24	5V, 141mA

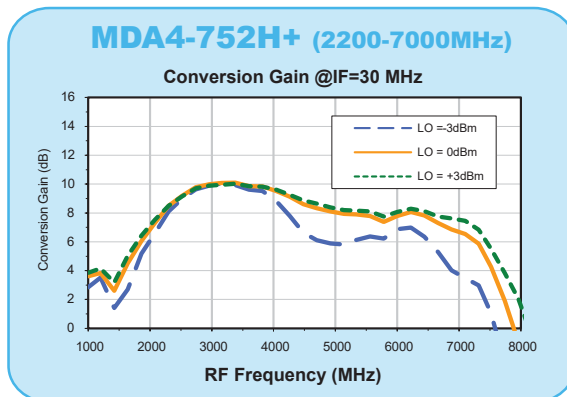
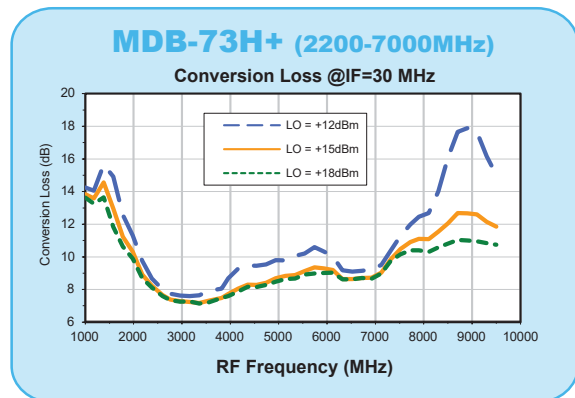
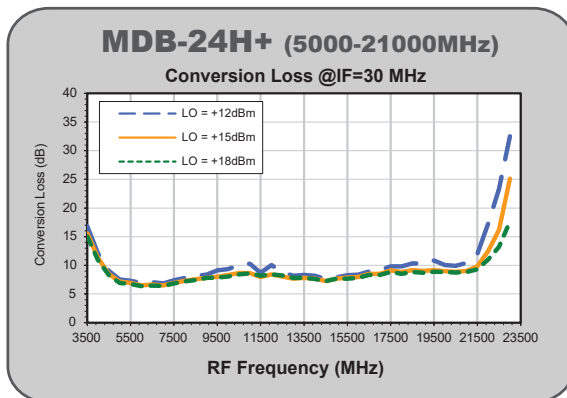

# Frequency Multipliers

Mini-Circuits' CY2-143+ is an ultra-wideband MMIC frequency doubler, converting input frequencies from 2 to 7 GHz into output frequencies from 4 to 14 GHz. Its wide output range makes this model suitable for broadband systems as well as a wide variety of narrowband applications. Utilizing GaAs HBT technology, the multiplier comes housed in a tiny 4 x 4 x 1 mm MCLP package and offers excellent repeatability, low inductance, good thermal efficiency, and low cost.



**CY2-143H+ (5000-21000MHz)**

- Ultra-wideband, output from 4 to 14 GHz
- Wide input power range, +12 to +18 dBm
- Low conversion loss, 12 dB
- Good fundamental and harmonic suppression: F1, 30 dBc; F3, 32 dBc
- Tiny size, 4 x 4 x 1 mm
- Low cost

**Conversion Loss X2 Output**

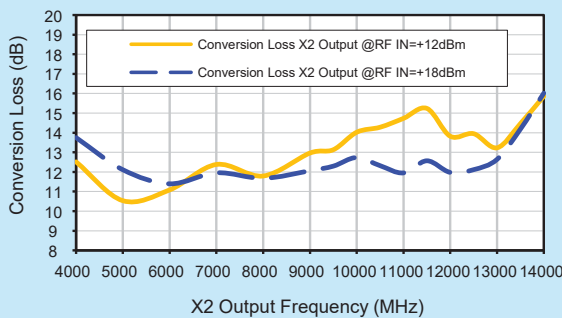

**Harmonic X1 Output**

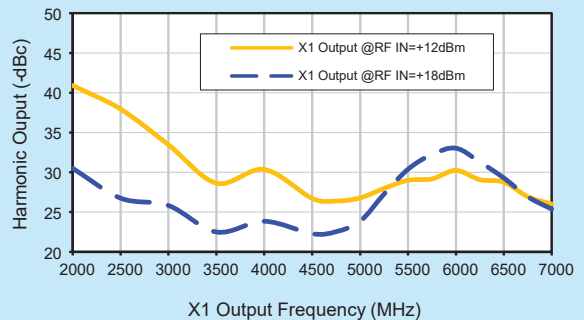

**Harmonic X3 Output**

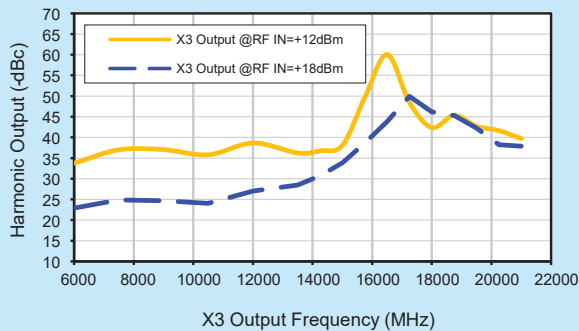

**Harmonic X4 Output**

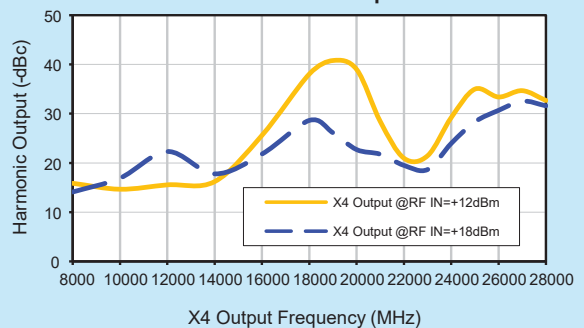

# QUALITY MANUFACTURING PROCESS & CONTROL

Mini-Circuits is committed to building products which meet or exceed customer's expectations. Mini-Circuits produce products using the highest quality and reliability standards.

## Advanced Packaging Technology

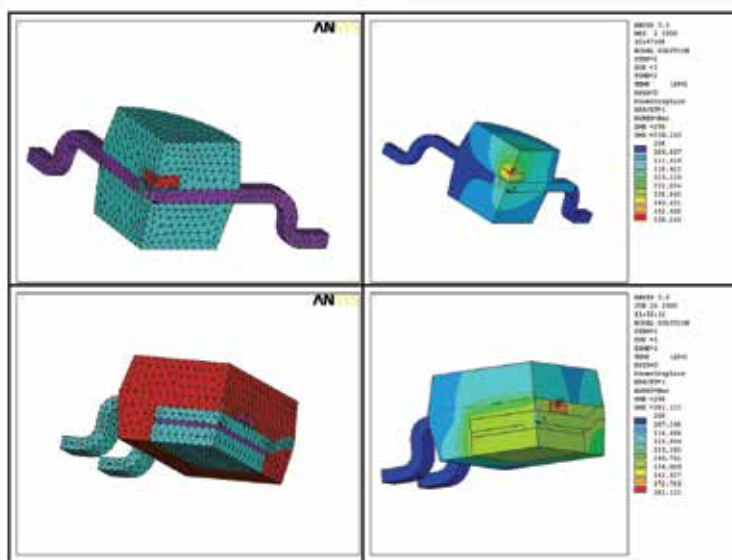

### Thermal Management

At Mini Circuits, we know temperature has a direct impact on the operating performance and reliability of MMIC products. During material selection, we use mold compound, lead frame materials and package designs with excellent heat dissipation properties that improve product performance and long-term reliability.

#### Thermal Conductivity (W/m° K)

Material	Mini-Circuits	Competitors
Mold Compound	1.5	0.88
Conductive Epoxy	45	2.5

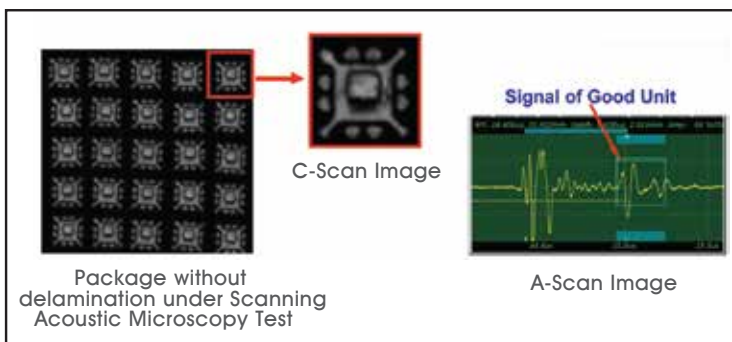

### Moisture Sensitivity Level 1

Our proprietary package design meets MSL Level 1 standards and eliminates the risk of package delamination, ensuring long term product reliability under all operating and assembly conditions.

# Comprehensive Test & Characterization

Mini-Circuits uses state-of-the-art RF measurement equipment to characterize and qualify our MMIC product designs. Characterization and qualification testing such as S-parameter testing, power testing, noise figure testing, IP3 testing, and load and source pull testing allow our designers to validate every product design's performance and provide comprehensive performance analysis for each model.

- ▶ S-Parameter Test
- ▶ Power Test
- ▶ Noise Figure Test
- ▶ IP3 Test
- ▶ Load / Source Pull Test



## Dynamic Test Specification

In pursuit of our goal to exceed our customer's expectations, we test our products to statistically generated 4.5 sigma limits instead of the specification limits. As a result, the products that are shipped to our customers are very consistent in performance with tight distribution.

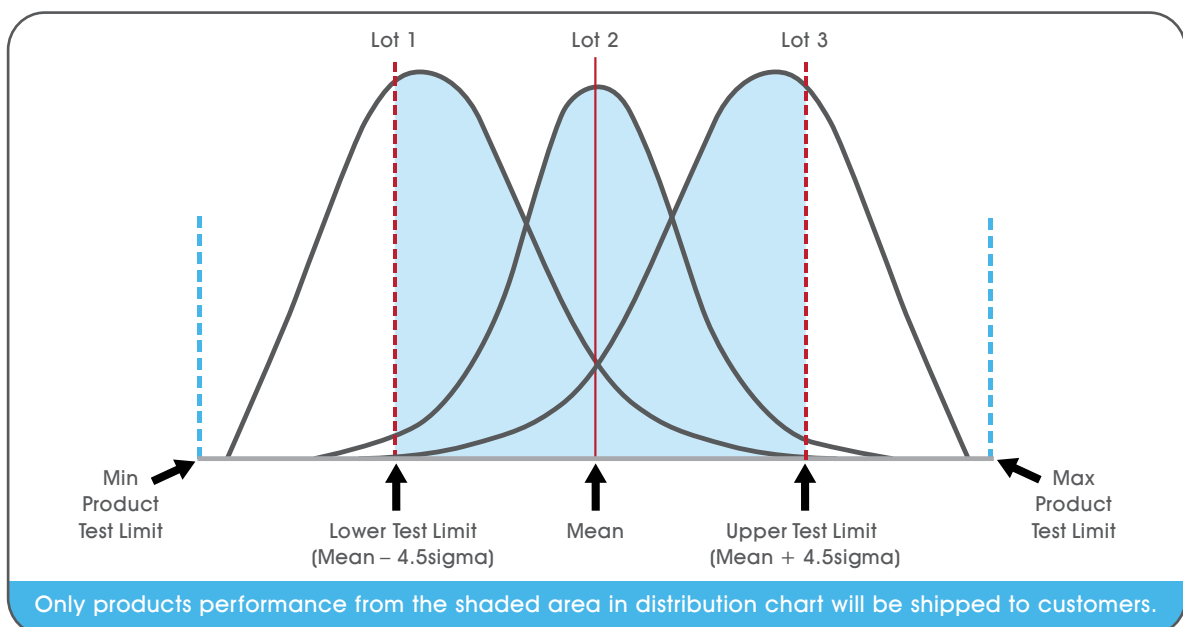

# Stringent Qualification

Our MMIC products undergo extensive and stringent qualification testing to ensure every unit delivers the quality you expect and reliability you can count on.

Test	Standard
High Temperature Operating Life Test (HTOL)	JEDEC Standard, JESD22A-108
Moisture Sensivity Test (Level 1)	JEDEC Standard, J-STD-020
Temperature Cycle Test	MIL-STD-883, Method 1010
Autoclave Test	JEDEC Standard, JESD22-A102
High Temperature Storage Test	JEDEC Standard, JESD22-A103
Scanning Acoustic Microscope Test	JEDEC Standard, J-STD-020C
Humidity Test	MIL-STD-202F, Method 103B
Solderability Test	JEDEC Standard, JESD22-B102
Lead Integrity Test	MIL-STD-883, Method 2004
Whisker Growth Test	JEDEC Standard, JESD22-A121
ESD Sensitivity Test	ANSI/ESD-STM5.1-2007 (HBM)



# COMPANION PRODUCTS & OTHER RESOURCES

## Companion Products

### 90° Hybrids

- 5 to 8000 MHz
- Power handling up to 15W
- Low phase and amplitude unbalance
- LTCC packages as small as 0805

### Baluns

- 4 kHz to 18 GHz
  - LTCC packages as small as 0805
  - Insertion loss as low as 0.5 dB
  - Low phase\* and amplitude unbalance
- \*relative to 180°*

### Bias Tees

- 0.1 to 10000 MHz
- Isolation up to 44 dB
- Insertion loss as low as 0.35 dB
- VSWR as low as 1.05:1

### Limiters

- 0.2 to 8200 MHz
- Input powers from +5 to +37 dBm
- Response time as fast as 2ns
- Hi-rel ceramic packages available

### LTCC Filters

- DC to 18.3 GHz
- Low pass, high pass, band pass, and diplexers
- Sharp rejection
- Ceramic packages as small as 0603



## Extensive Application Notes

As part of our commitment to providing you with best in class product information and application support, our online library of application notes contains over 40 articles with detailed technical information regarding uses of many of our MMIC products in different systems and operating environments.

### Go to:

[www.minicircuits.com/applications/application\\_notes.html](http://www.minicircuits.com/applications/application_notes.html)

You can also request an application note specifically for the work you're doing by reaching out to us at [apps@minicircuits.com](mailto:apps@minicircuits.com). We're here to support you!

## Advanced Simulation Models

Mini-Circuits has always provided customers with free S-Parameters for all models to support performance modeling and simulation over linear power domains. To allow designers to accurately model the complete linear and non-linear performance of their designs, Mini-Circuits now provides free **X-Parameters®** for three of our most popular MMIC amplifiers: PHA-1+, GVA-62+, and GVA-63+.

Made possible through our partnership with modeling and measurement specialists, Modelithics, this advanced capability is ideal for use in systems with complex waveforms like LTE, OFDM and QAM, as well as for prediction of power compression, non-linear distortion, and other behaviors elusive to conventional simulations.

Made possible through our partnership with modeling and measurement specialists, Modelithics, these X-parameters models enable faster, more comprehensive feasibility assessments and more rapid transition from prototype simulations to working designs. For more information...

### Go to:

[http://www.minicircuits.com/products/x\\_parameters.shtml](http://www.minicircuits.com/products/x_parameters.shtml)

FREE X-Parameters-Based  
Non-Linear Simulation Models for ADS



<http://www.modelithics.com/mvp/Mini-Circuits.asp>

# MINI-CIRCUITS NEW MMIC PRODUCTS



U.S. Patents  
7739260, 7761442

## Find the Right Model for Your Needs in Seconds!

Why waste time searching for a needle in a haystack? Instead of combing through tables and datasheets of hundreds of possible MMIC options for the one that fits your requirements, visit [minicircuits.com](http://minicircuits.com) and use *Yoni2*®, our patented RF product search engine. *Yoni2*® searches thousands of actual test data points from our entire database of catalog models and non-catalog engineering designs for the amplifiers that meet or exceed your criteria. Just visit the *Yoni2*® page. Within seconds, *Yoni2*® will present a list of components that match your criteria based on how they actually perform across your specific frequency band!



## Go to:

[www.minicircuits.com/products/Yoni.shtml](http://www.minicircuits.com/products/Yoni.shtml)

Still didn't find what you're looking for? We may be able to create a custom design especially for you. Reach out to us using the contact information below. We're here to support you!

## Direct Sales

- ▶ **Brooklyn**  
sales@minicircuits.com  
1 718-934-4500
- ▶ **Missouri**  
sales@minicircuits.com  
1 417-335-5935
- ▶ **Europe**  
sales@uk.minicircuits.com  
44 1252-832600
- ▶ **Taiwan**  
robert@min-kai.com.tw  
886 3 318 4450

## Technical Support

- ▶ **North America**  
apps@minicircuits.com  
(718) 934-4500
- ▶ **Singapore, Indonesia  
Malaysia, Thailand**  
sales@minicircuits.com.my  
(604) 646-2828
- ▶ **Israel**  
app@ravon.co.il  
972 4 8749100
- ▶ **Taiwan & Philippines**  
robert@min-kai.com.tw
- ▶ **Europe**  
apps@uk.minicircuits.com  
44 1252 832600
- ▶ **India**  
apps@minicircuits.com  
91 44 2 2622575
- ▶ **China**  
sales@minicircuits.com  
0591-8787-0001  
Or  
yuanzhong@minicircuits.com  
20-8734 0992